

Garmin®

**MARINE
INSTRUMENTS**

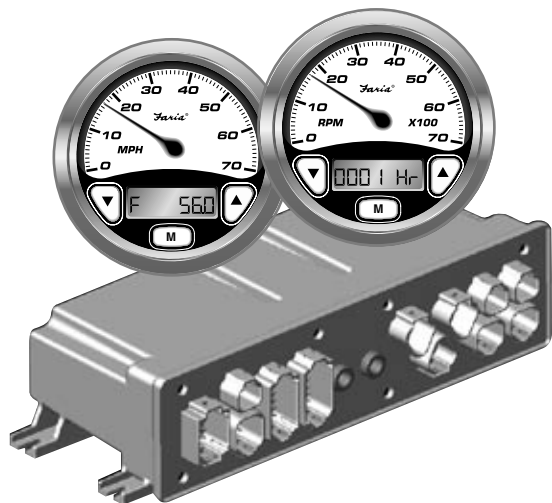

Serial Bus for CorrectCraft® Pleasurecraft GM Engines

Owner's Manual

- Visual /Audible Alert Messages
- Easy Installation
- Waterproof Connections
- Easy to Read Digital Displays
- Easy to use Depth Sounder
- Multiple Interfaces

ISO1511

ISO1511C ECR#4418 03/08/2004

Initial Setup

Selecting the Fuel Tank Size Page 2

Operation

General Page 2

Speedometer/Depth Sounder

Speedometer Calibration Page 3

Dual Pitot Operation Page 4

Depth Sounder Page 4

Canceling Depth Alarms Page 4

Shallow Alarm Page 5

Deep Alarm Page 5

Keel Offset Page 6

Units Page 6

Speedometer Mode Display Sequence- Figure 1 Page 7

Tachometer/Fuel Monitor

General Page 8

Canceling System Alarms Page 8

Engine Hourmeter Page 8

Hours Remaining Page 9

Engine Temperature Page 9

Voltmeter Page 9

Oil Pressure Page 9

Instrument Lighting Page 9

Tachometer Mode Display Sequence - Figure 2 Page 10

LCD Alarm Condition Displays Page 10-11

Installation/Harness wiring guide for PleasureCraft GM Engines

Gateway Page 13

Gateway Harness connections

Figure 3 Typical Power Connections Page 14

Figure 4 Typical Instrument Connections Page 14

Figure 5 PleasureCraft GM Engine ECU Connection Page 15

Figure 6 Transducer and Pitot Tube Connections Page 15

Figure 7 Miscellaneous Connections Page 16

Wire Harness/Connections - Table 1 Page 17

System

The system consists of:

- One Gateway box to interface with MEFI IV ECU and external senders and sensors.
- One 5" Tachometer with Fuel Monitor
- One 5" Speedometer with Depth Sounder
- optional second 5" Speedometer
- Various 2" instruments, including but not limited to
 - Voltmeter
 - Oil Pressure gauge
 - Fuel gauge
 - Engine Temperature gauge
 - others as specified.

Initial Setup

The setup function is normally only used for a new installation. It is not required to follow this procedure every time the instruments are turned on.

The tachometer is used to initialize the fuel tank size required for the fuel management function. Press and hold the "mode M" button while turning the power on, to enter the "setup" mode.



Mode
Button

The LCD will show the current fuel tank size selection. The choices are displayed with the "Up" or "Down" buttons. After selecting the closest tank size, press and hold the "mode M" button for 3 seconds to save the selected size and start normal instrument operation.



Select from one of the following fuel tank capacity options:

- 29 gallon
- 30 gallon (default)
- 35 gallon
- 39 gallon
- 50 gallon

Operation

General

The Faria® Serial Bus™ system is designed to receive information from the engine ECU and various individual sensors throughout the boat. This information is transformed into digital data which is distributed to analog and digital instruments via a single cable consisting of two shielded, twisted pairs of conductors.

Each instrument selects the data which is applicable and displays it as if it was being received from the sender directly. One of the two pairs of conductors carries the data while the other pair of conductors carry the power for the instruments.

The tachometer and speedometer each have three push buttons which allow the different functions of each instrument to be activated. Following is a description of these functions.



Mode
Button



Down
Button



Up
Button

Speedometer / Depth Sounder

The Serial Bus Speedometer / Depth Sounder provides both the functions of a speedometer and a depth sounder. The analog speedometer is a stepper motor instrument which looks like a standard analog device but which is actually a digital instrument. On small pointer movements you may occasionally see the pointer moving in the one third degree “steps” that represent the accuracy of the instrument.

Speedometer Calibration

The analog speedometer displays the speed of the boat through the water. The speedometer is calibrated at the factory for normal installations which use a pitot tube sensor. As significant variation has been found in various installations, the speedometer can be easily calibrated to a known reference such as a radar gun or GPS. The LCD will display;



When the unit is operating in normal mode (i.e. pitot status information on the LCD), push and hold the “mode M” button down for 2 seconds will cause the speedometer to go to the calibration mode.



The LCD will show “AdJUST”:



Run the boat at a constant 30 MPH as

measured by the GPS or radar. Adjust the speedometer pointer by pressing the “Up” or “Down” buttons until the speedometer matches the GPS or radar speed.

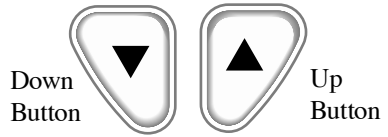

When finished, press the “mode M” button to exit the adjustment screen. The operator has the option of saving or canceling the adjustment procedure. The options can be selected using the “Up” or “Down” buttons. To save the calibration setting, press and hold the “mode M” button for 2



seconds when the display shows “SAVE”



To exit the adjustment procedure without saving, press and hold the “mode M”



button for 2 seconds when the display shows “NO SAVE”. Multiple runs in opposite directions may be necessary to compensate for errors due to water currents.

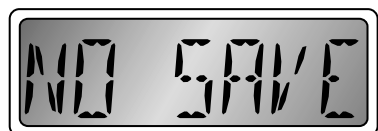

The speedometer also measures the water pressure in the pitot tubes when power is first turned on. This measurement is subtracted from later readings to correct for the pressure caused by the weight of water over the pitot pick-up.

For maximum accuracy, the boat should not be moving when the key is turned on, especially in a re-start condition. If the boat is moving, the pressure in the pitot will be greater than normal, resulting in the speedometer reading low.

Dual Pitot Operation

The system is designed to be operated with two pitot pick-ups for speed sensing. The speed displayed is based on the pitot with the highest pressure. On the speedometer LCD display, the active pitot sensor will be identified by a “P” or “S”. It is normal to see the display switch between the port and starboard pitot sensors, especially in high speed turns.

Both pitot sensors are continuously monitored, and blockage in either sensor will be detected. If a sensor becomes blocked, the system will switch to the clear pitot sensor. An “XX” will flash in place of the “P” or “S” on the speedometer LCD to indicate which sensor is blocked.



Port Sensor - Starboard blocked



Starboard Sensor - Port blocked

Clean the pitot sensor to restore normal operation.

Depth Sounder

The depth sounder is turned on and off with the ignition switch. The depth sounder can also be turned off at any time, while in depth display mode, by pressing and holding the “mode M” button while the depth sounder counts down a three second delay.



Mode Button

The depth display will then indicate “OFF”:



Press and hold the “mode M” button to turn the depth sounder back on.



Mode Button

The LCD screen displays the depth sounder data. When there are no alarm conditions, the water depth is displayed. If the signal is weak or lost, or there is no transducer connected, then the display will alternate between the last known depth and three horizontal bars.

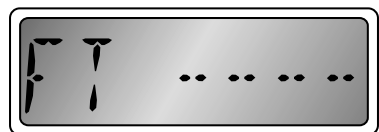

Canceling depth alarms

A depth alarm warning can be temporarily canceled by pressing both “Up” and “Down” buttons on the speedometer, simultaneously. After one minute, the

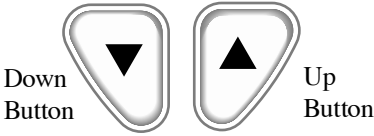

alarm will resume if the condition that caused the alarm is not corrected. The operator can cancel the alarm as many times as necessary, until the condition is corrected.

The depth alarm warning will replace any information on the LCD screen. Canceling the alarm will restore the LCD to the original display. If not already in the depth mode, this would be a good time to switch to it (using the “mode M” button) in order to monitor water depth.



Depth Sounder Alarm Settings

Note: *Speedometer display must be in depth display mode to change settings.*

To change the depth sounder alarm settings the “mode M” button must be held down until the depth display changes to the alarm settings mode.



There are four menus in the alarm settings mode. Pressing and releasing the mode switch quickly will cycle through the different options.

Shallow alarm

Alarm sounds when water depth equals or is less than the set value.

The display will show “S XX.X”



which is the current setting for the shallow alarm. Pressing the “Up” or “Down” buttons will change the shallow setting.

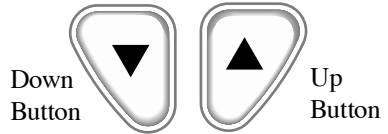

Holding the “mode M” button in for 2 seconds will save the new shallow setting and change the display back to the normal depth mode. **Set to zero to disable alarm.**



Deep alarm

Alarm sounds when water depth equals or is greater than set value.

The display will show “d XX.X”; which is the current setting for the deep alarm.



Pressing the “Up” and “Down” buttons will change the deep setting.

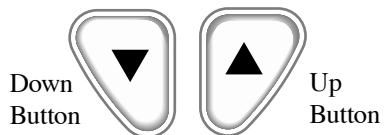

Holding the “mode M” button in for 2 seconds will save the new deep setting and change the display back to the normal depth mode. **Set to zero to disable alarm.**



Mode Button

Keel offset

Adjust depth sounder to measure depth below keel or drive instead of sensor.

The display will show “K X.X” which is



the current setting for the keel offset. Pressing the “Up” or “Down” buttons will change the keel offset setting.

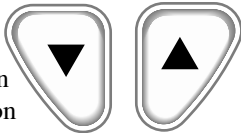

Down Button

Up Button

Holding the “mode M” button in for 2 seconds will save the new keel offset setting and change the display back to the normal depth mode. The Keel offset is normally a negative number.



Mode Button

Units

Change the unit of measure.

The display will show “UNIT FT” for feet, “UNIT FA” for fathoms, or “UNIT M” for meters. Pressing the “Up” or “Down”

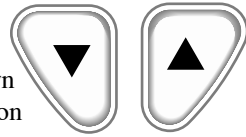

Down Button

Up Button

buttons will cycle through the choices. Pressing and holding the “mode M” button will save the units shown in the display and change the display back to the normal depth mode.



Mode Button

Feet (default)

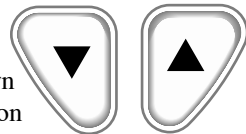
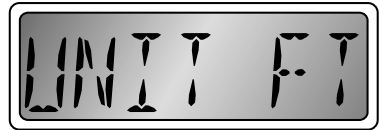

Down Button

Up Button

Meters

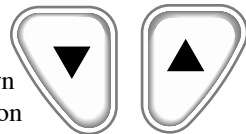
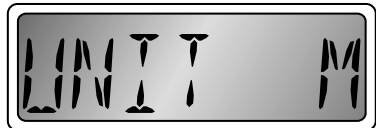

Down Button

Up Button

Fathoms

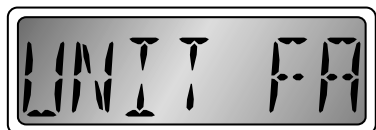

Speedometer Display Sequence

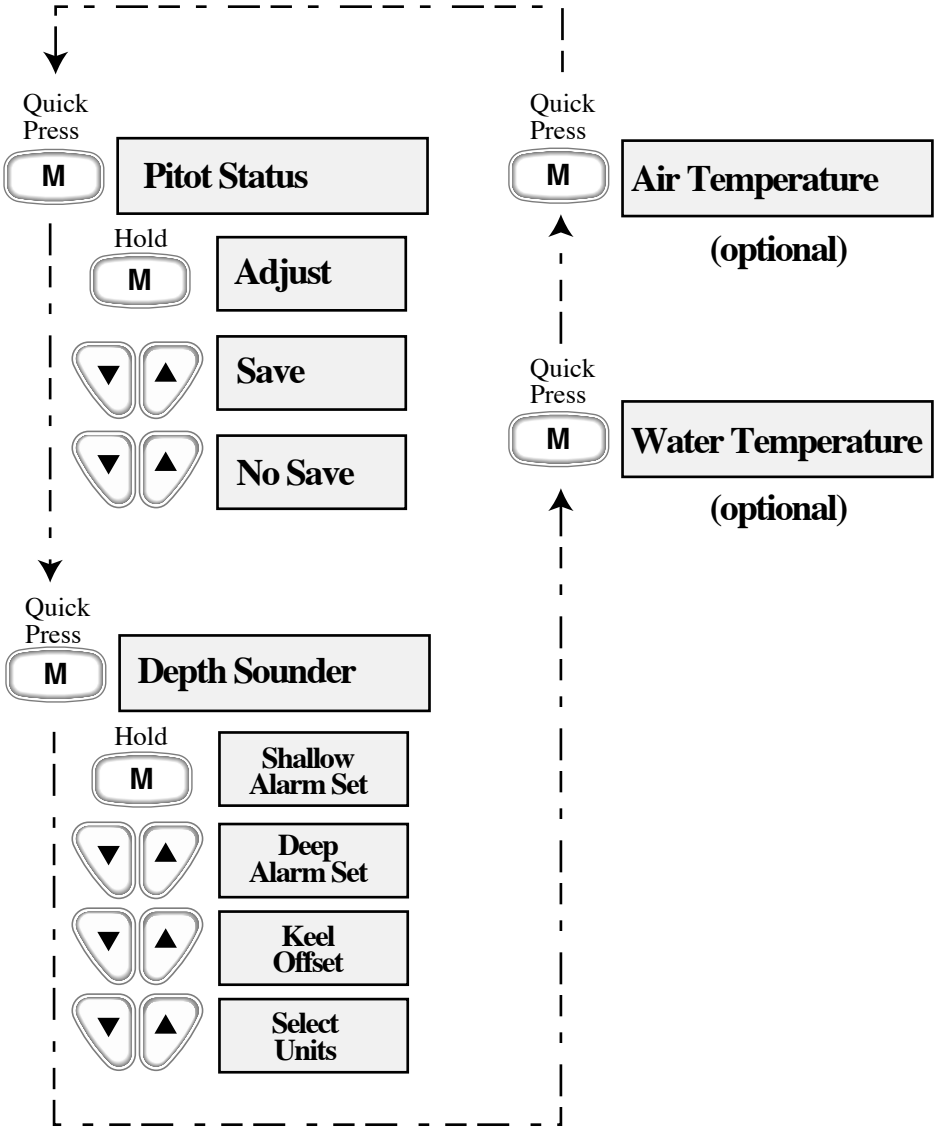

Figure 1

Tachometer / Fuel Monitor

The Serial Bus Tachometer / Fuel Monitor instrument provides both the functions of a tachometer and a fuel - engine monitoring system. The analog tachometer is a stepper motor instrument which looks like a standard analog device but which is actually a digital instrument. On small pointer movements you may occasionally see the pointer moving in the one third degree “steps” that represent the accuracy of the instrument.

The tachometer LCD screen displays several functions. The displayed data includes “engine hours”, “time remaining”, “engine temperature”, “oil pressure”, “system voltage”, and engine alarm conditions.

Pressing the “mode M” button will select



Mode
Button

the various functions as shown in **Figure 2**.

In order to minimize “false” alarms, the “low fuel” and “low voltage” alarms only function when the engine is known to be running based on the presence of tachometer data.

Several alarm conditions may also be displayed in the LCD display when needed:

- 1 Low fuel
- 2 Low oil pressure
- 3 High engine temperature
- 4 Low voltage
- 5 Engine RPM reduction due to engine controller command

- 6 RPM limit
- 7 Knock sensing system malfunction
- 8 Ignition system malfunction
- 9 Manifold pressure sensor (MAP) malfunction
- 10 Manifold temperature sensor malfunction
- 11 Throttle position sensor (TPS) malfunction
- 12 Coolant sensor malfunction

Alarm messages will be displayed on the tachometer LCD display. Messages 1-5 will also include a flashing red light. All messages will be displayed until either the problem is corrected or the operator manually cancels the warning message.

Canceling system alarms

To manually cancel system warning messages, simultaneously press both the “Up” and “Down” buttons on the tachometer.

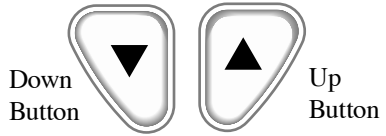

This will disable the warning message temporarily. If the problem is not corrected in 1 minute (5 minutes for low fuel), the warning will be displayed again. The operator can cancel as often as desired.

Engine Hourmeter

Displays the number of hours that the engine has been operated. The display will show “XXXX.XHr”:



Hours Remaining

The “time remaining” display shows how many hours the boat can operate based on the fuel remaining in the tank and the current fuel usage rate.



Engine Temperature

Displays the Coolant Temperature of the Engine. There are no adjustments available.



Voltmeter

Displays the System Voltage. There are no adjustments available.



Oil Pressure

Displays current Oil Pressure. There are no adjustments available.



Instrument Lights

The navigation light switch must be on for the instrument lights to function. The “Up” and “Down” buttons on the tachometer control the instrument lighting brightness.

Pressing the “Up” button increases light intensity.



Up
Button

Pressing the “Down” button decreases light intensity.



Down
Button

Tachometer Display Sequence

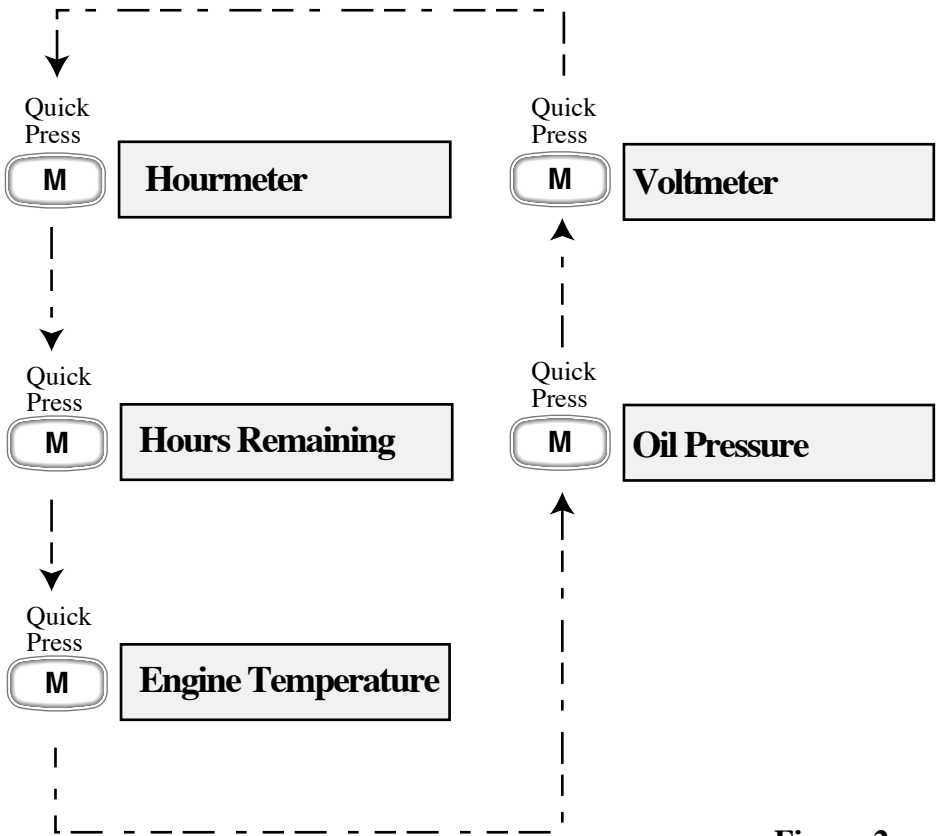

Figure 2

LCD Alarm Condition Displays.

Alarm messages will be displayed on the Tachometer LCD display. All messages will be displayed until either the problem is corrected or the operator manually cancels the warning message.

Messages will display as a many screens shown sequentially,

Canceling System Alarms

To manually cancel system warnings

messages, simultaneously press both the “Up” and “Down” buttons on the

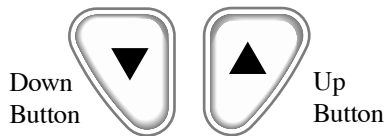

tachometer. This will disable the warning message temporarily. If the problem is not corrected in 1 minute (5 minutes for low fuel), the warning will be displayed again. The operator can cancel as often as desired.

Severe Conditions- Includes a Flashing Red Light

Low Battery Voltage (Flashing Red Light)



High Engine Temperature (Flashing Red Light)



Low Oil Pressure (Flashing Red Light)



Low Fuel Level (Flashing Red Light)



RPM Reduction in Progress (Flashing Red Light)



Warnings

Engine Speed Limiter Active



Knock Detection System Malfunction



Spark Delivery System Malfunction



Manifold Pressure System Malfunction



Manifold Air Temperature Sensor Malfunction



Throttle Position Sensor Malfunction



Coolant Temperature Sensor Malfunction



This page left blank intentionally.

Faria Serial Bus Installation and Wiring Guide (Pleasurecraft Engines)

The system consists of:

- One Gateway box to interface with MEFI IV ECU and external senders and sensors.
- One 5” Tachometer with Fuel Monitor
- One 5” Speedometer with Depth Sounder
- One 5” Optional Speedometer
- Various 2” instruments, including but not limited to
 - Voltmeter
 - Oil Pressure gauge
 - Engine Temperature gauge
 - Fuel Level gauge
 - others as specified.

Installation

Installation of the Faria Serial Bus system is accomplished as follows:

Gateway Box

The “gateway” box is the central unit of the system. As all of the senders and other information source peripherals connect to the “gateway”, the “gateway” box should be mounted in a protected area in the best location to provide the maximum cabling benefit.

The “gateway” box power cable must be installed to allow connection to “battery positive” (always on), “battery negative” (ground), and a source of “switched power” which turns on with the engine ignition switch (see Figure 3 and Table 1).

The “Faria Bus” cable must be routed from the “gateway” box to the instrument panel area to connect the instruments to the data bus and instrument power (see Figure 4).

The remainder of the connections to the “gateway” box are described below.

Instruments

The instruments are mounted using the provided back-clamps and mounting hardware. Each instrument comes with a bus connection cable (12”). The main “Faria Bus” cable from the “gateway” box is connected to the most convenient instrument using either of the two four (4) pin connectors provided on the instrument case (*except when a Faria Serial Bus Pilot or a Faria Speedometer-PerfectPass Cruise instrument is installed, see note below).

Each additional instrument is connected to the previous instrument using one of the 12” bus connection cables. The cable may be connected to either of the two connectors provided on the instrument case (see Figure 2).

*NOTE: The Faria Serial Bus Pilot and the Faria Speedometer-PerfectPass Cruise instruments are “end of the bus” instruments. Only the provided four (4) pin connector is to be connected to the “Faria Bus”. See special instructions for use of the six (6) pin connector on these instruments.

Typical Power Connections

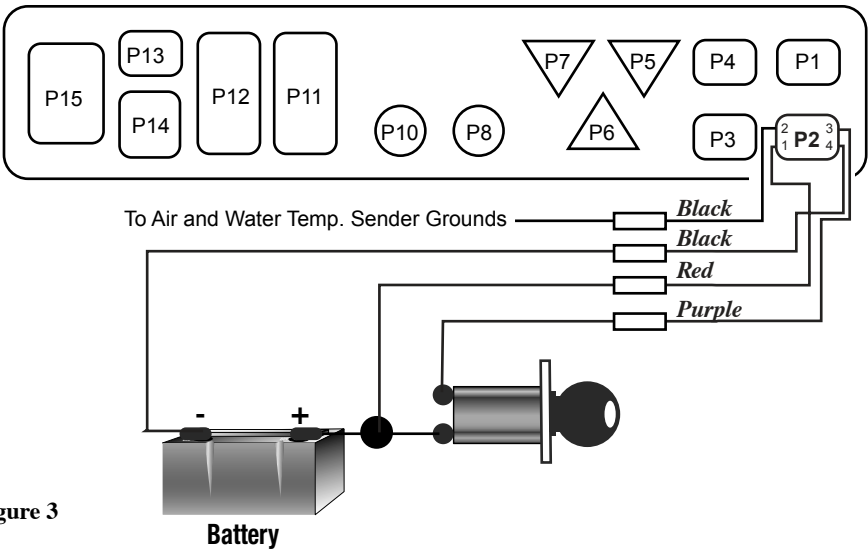

Figure 3

Typical Instrument Connections

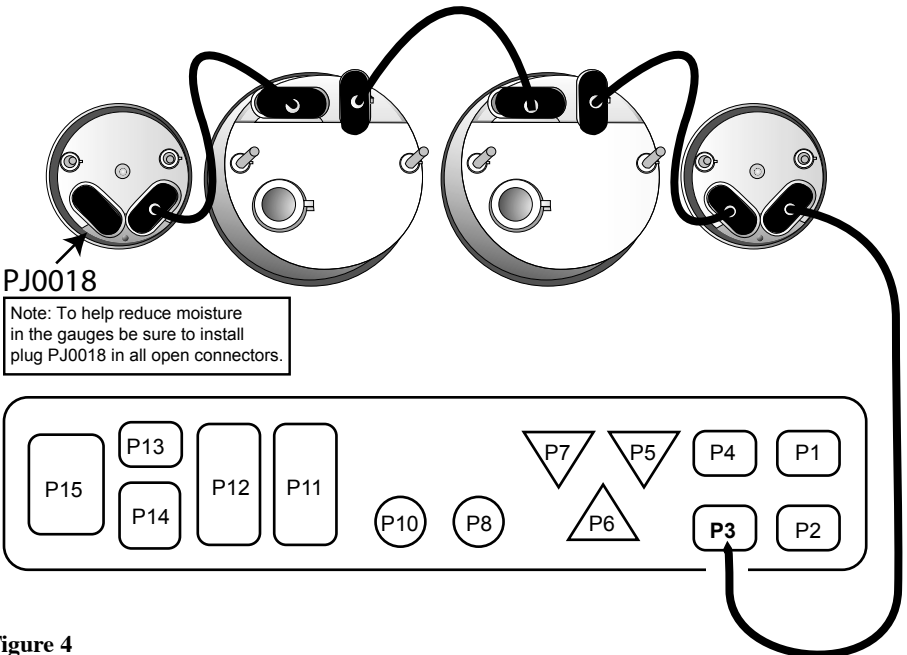

Figure 4

Pleasurecraft GM Engine ECU Connection

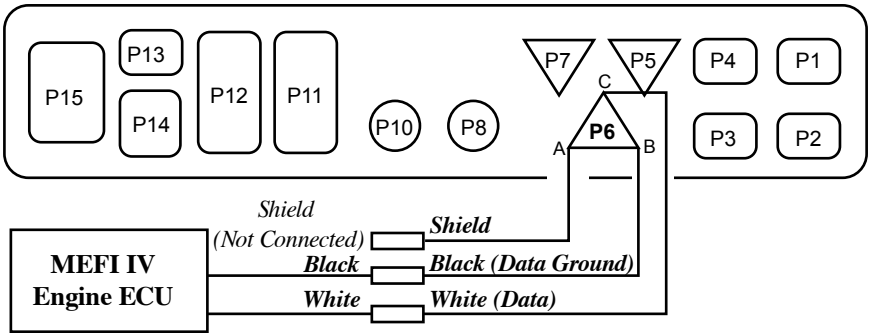

Figure 5

Transducer and Pitot Tubes Connections

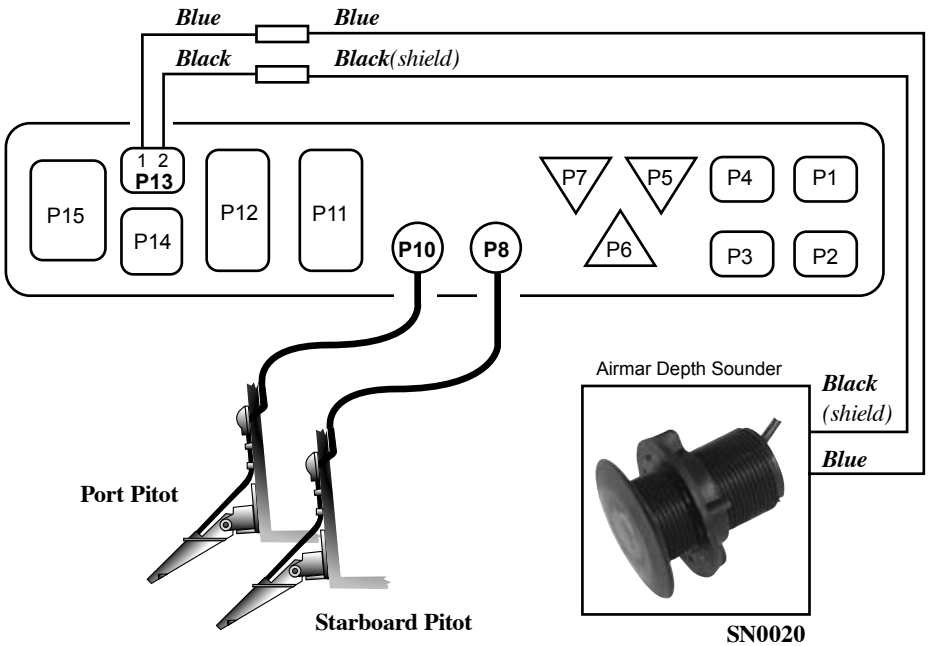

Figure 6

Miscellaneous Connections

Figure 7

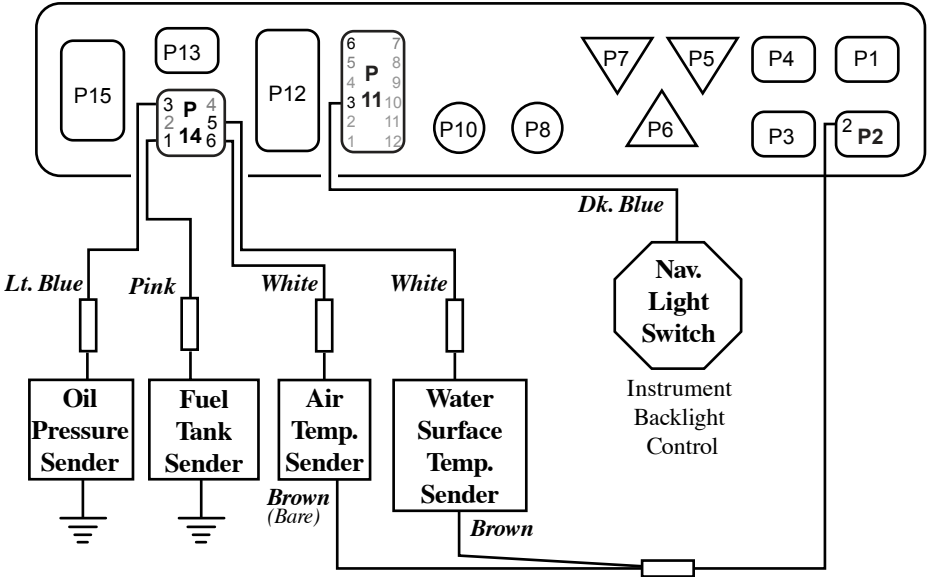

Table1

| Connector | Contacts | Pin | Pin Function | Wire Color |
|-----------|----------|------------------|--|-------------------------------------|
| P1 | 2 | | Not used | |
| P2 | 4 | 1 2 3 4 | Battery Positive (always on)* Ground (Temp. Sender) Switched Power from Ignition switch circuit Ground | Red Black Purple Black |
| P3 | 4 | All | Faria® Bus Data and Instrument Power | N/A |
| P4 | 2 | | Not Used | (PJ0015) |
| P5 | 3 | | Not Used | (PJ0016) |
| P6 | 3 | | MEFI IV Engine ECU | N/A |
| P7 | 3 | | Not Used | N/A |
| P8 | PP | | Starboard Pitot | |
| P9 | PP | | Not Used | |
| P10 | PP | | Port Pitot | |
| P11 | 12 | 3 | Navigation Lights Input | Dk. Blue |
| P12 | 12 | | Not Used | |
| P13 | 2 | 1 2 | Depth Sounder Transducer signal (AirMar Transducer) Depth Sounder Transducer Ground (AirMar Transducer) | Blue Black |
| P14 | 6 | 1 3 5 6 | Fuel Tank Sender Oil Pressure Sender Water Surface Temperature Air Temperature | Pink Lt. Blue White White |
| P15 | 8 | | Not Used | |

*5 amp Fuse Recommended

Notes

Copyright 2004 by the Thomas G. Faria Corporation, Uncasville, CT USA

No part of this publication may be reproduced in any form, in an electronic retrieval system or otherwise, without the prior written permission of the company.

Faria® is the trademark of the Thomas G. Faria Corporation